

Světová Metra přehled a vybrané projekty

D2

Metro Systems, overview and selected projects

Martin SRB

Tunelářské odpoledne CzTA ITA – AITES

VÝSTAVBA MĚSTSKÝCH PODZEMNÍCH DRAH V ZAHRANIČÍ

Praha 21. března 2012

Témata a obsah přednášky

- **Metra – definice, historie a současnost**
- **Přehled projektů a činností D2 Consult**
 - Amerika
 - Evropa
 - Asie
- **Vybrané projekty**
 - Washington D.C., Seattle Wa., Edmonton, Canada
 - Budapest
 - Delhi, Bangkok

Definice Metra

- **Městský/metropolitní veřejný systém pouze pro osobní dopravu**
- **Elektrifikovaný**
- **Velká kapacita a vysoká frekvence**
- **Oddělení od jiných dopravních systémů**
- **Žádná úrovňová křížení s jinými systémy (silnice, železnice, cyklo, pěší,...)**

Některé systémy jsou nazývány Metro, přestože kriteria nesplňují a naopak (heavy urban rail, light rail, commuter rail, ...)

**Trasa v podzemí (velikost TT) i nad zemí
Stanice**

Městské podzemní dráhy (Metra) – historie a současnost

Velká Británie

- 1863 Londýn, 6km
- 1884 Londýn 20km, okružní
- 1890 první ražený úsek, Londýn, 4km
- 1896 Glasgow, 10,4km

Evropa kontinentální

- 1896 Athény, 4km
- 1896 Budapešť
- 1900 Paříž, 1902 Berlín

Amerika

- 1897 Boston
- 1900 Chicago , 1904 New York,

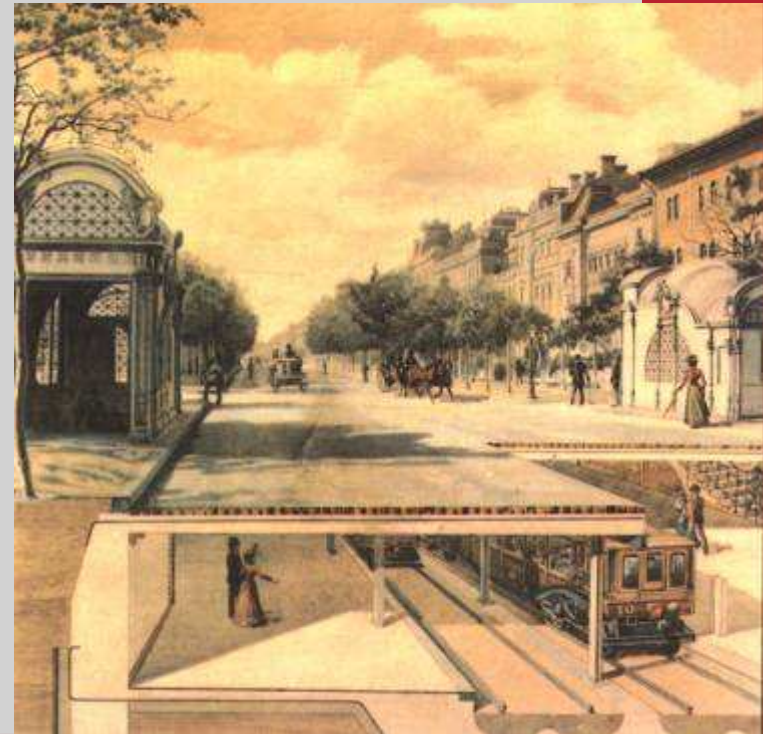

Městské podzemní dráhy (Metra) – historie a současnost

Kolik? ~ 160 - 180

Kde ?

Města > 1 milion

- **Evropa (~ 70)**
- **Afrika (2)**
- **Amerika (~ 40)**
- **Asie (~ 60)**

Proč?

Jak?

- **Jako Praha**



Strana 5

Městské podzemní dráhy (Metra) – historie a současnost

#	City	▽ Daily ridership	Network length	Stations
1	 Tokyo	8.7 million	304.5 km	290
2	 Moscow	6.55 million	306.2 km	185
3	 Seoul	5.61 million	316.3 km	293
4	 New York	4.33 million	368.0 km	468
5	 Paris	4.05 million	215.0 km	381
6	 Beijing	3.99 million	337.0 km	196
7	 Mexico City	3.88 million	201.7 km	175
8	 Hong Kong	3.62 million	175.0 km	95
9	 Shanghai	3.56 million	423.0 km	279
10	 London	2.99 million	402.0 km	270

Přehled projektů

AMERIKA – Severní, Jižní

- *Fort Totten Station, MTA Washington DC - USA*
- *Metro Red Line, Los Angeles - USA*
- *Seattle Link Light Rail - USA*
- *East Side Access (ESA) New York – USA*
- *San Juan, Puerto Rico*
- **Suburban Train Caracas-Guarenas-Guatire - Venezuela**
- *Edmonton LRT*
- **Santiago, Chile**

Přehled projektů

EVROPA

- **Munich, Germany**
- **Milano, Italy**
- **Paris, France**
- **Metro Lille, France**
- **Stuttgart Lot 601 - Germany**
- ***Metro Line 4 Budapest - Hungary***

ASIE

- ***Metro New Delhi, India***
- **Metro Thomson Line, Singapore**
- ***Metro Blue Line and Purple Line Bangkok – Thailand***

Přehled činností „konzultační“ firmy (Consultants, Consulting Engineers, Planung&Beratung,...)

„ENGINEERING“ ~ PROJEKTOVÁNÍ

- **Design (preliminary, tender & detailed design)**
- **Feasibility studies**
- **Environmental impact studies**
- **Construction contracts**
- **Project development**
- **Time and cost estimates**
- **Cost analysis**
- **Cost-benefit analysis / Value engineering**
- **Risk analysis**

Přehled činností „konzultační“ firmy

„CONSULTING“ ~ KONZULTAČNÍ ČINNOST

- Construction supervision
- Independent third-party review and design check
- Project management
- Contract management
- Expertises
- Technical assistance
- Advisory services
- Arbitration
- Training

„RESEARCH & DEVELOPMENT“ ~ V&V

Strana 10

Milestones – Milníky

1976 Metro (U-Bahn) Bochum, Germany

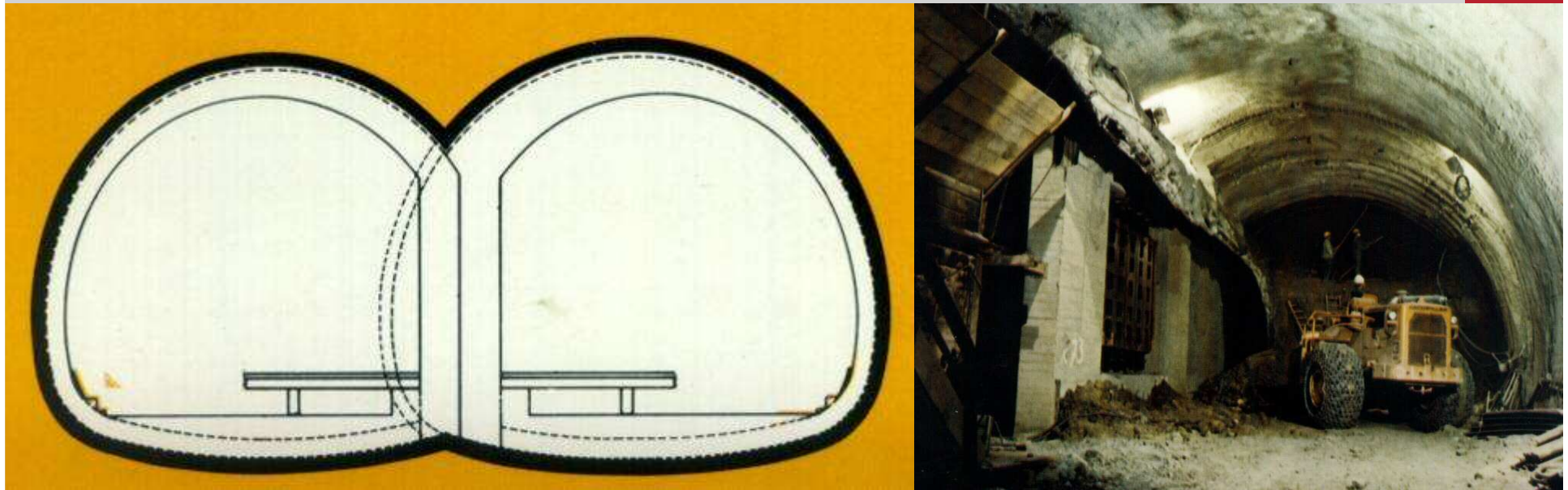

**The First NATM Subway Station world wide
Berliner Platz, Cross section, Construction**

Strana 11

Milestones – Milníky

1991 Metro Station Washington DC, USA



The First NATM Station in soft ground
“Fort Totten Station“ - Completed Structure

Milestones – Milníky

1991 Metro Station Washington DC, USA



**The First NATM Station in soft ground
“Fort Totten Station“ - Completed Structure**

Strana 13

Milestones – Milníky

1991 Fort Totten Metro Station, Washington DC, USA

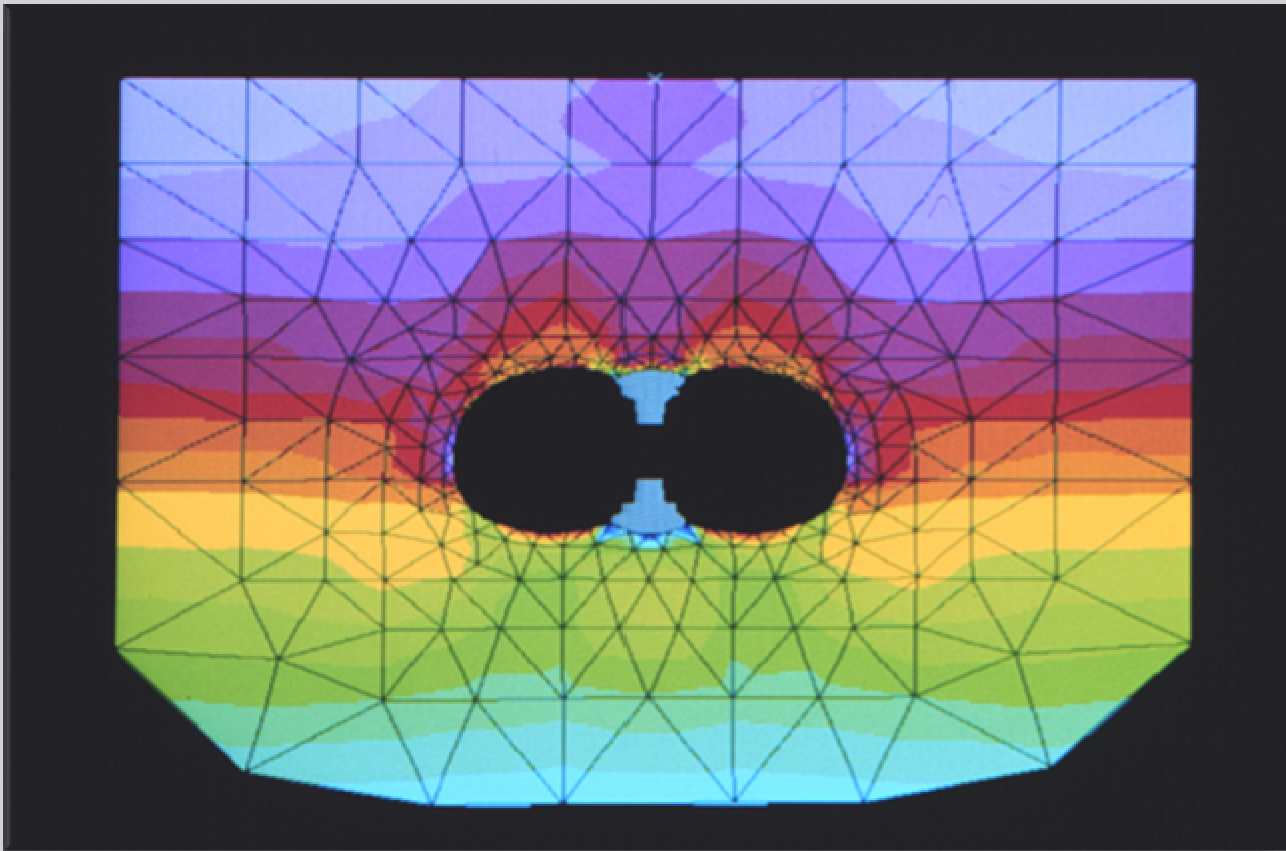

The First NATM Station in soft ground (in USA)
Numerical analysis

Strana 14

Milestones – Milníky

1991 Fort Totten Metro Station, Washington DC, USA

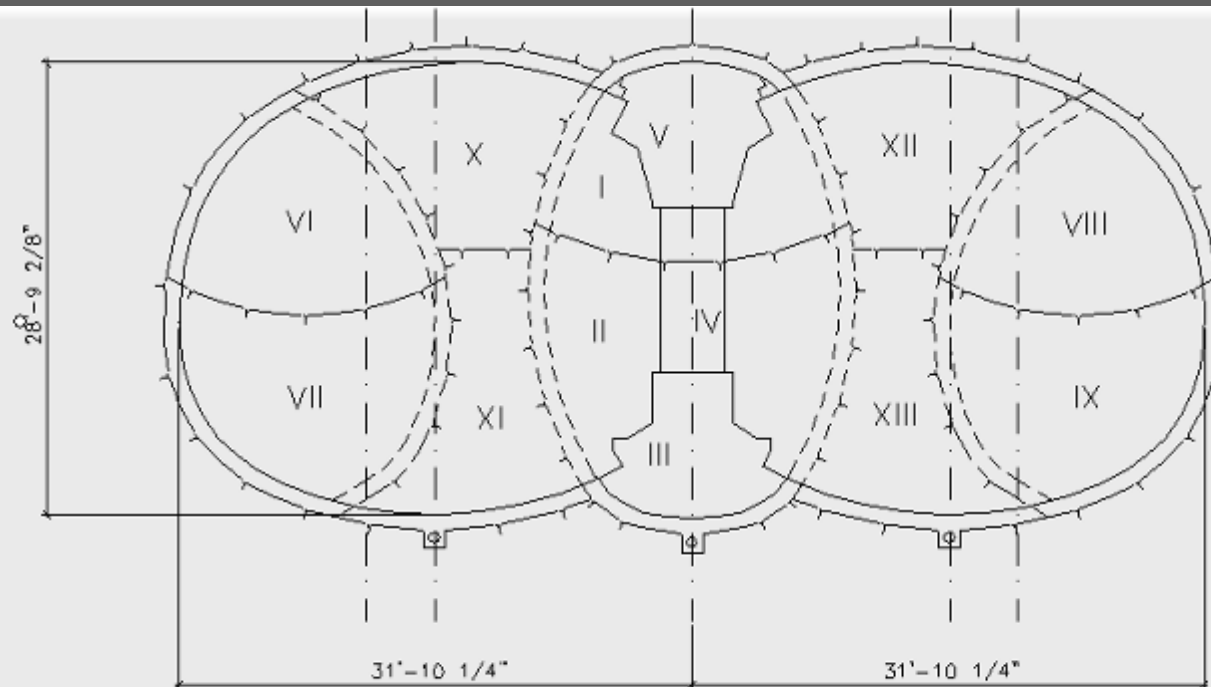

- PHASE 1: I – V
- PHASE 2: VI – VII
- PHASE 3: VIII – IX
- PHASE 4: X – XI
- PHASE 5: XII – XIII

Milestones – Milníky

1991 Fort Totten Metro Station, Washington DC, USA

Sectional construction of the station

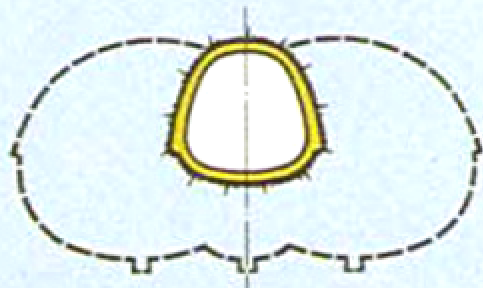

1 Excavation and support of crown of center drift

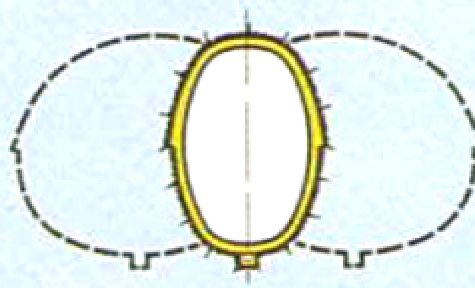

2 Excavation and support of bench of center drift

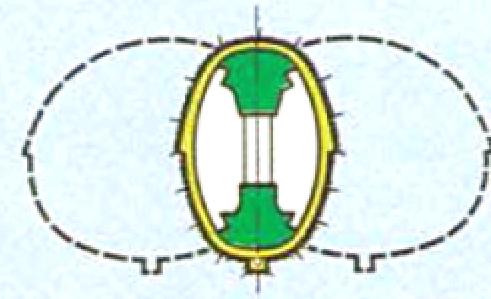

3 Construction of support frames

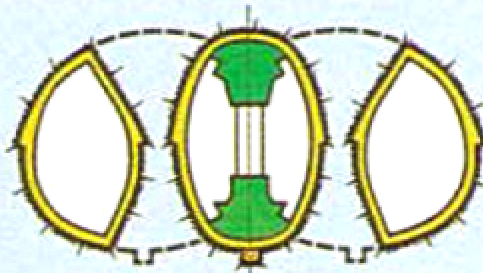

4 Excavation and support of the two side drifts

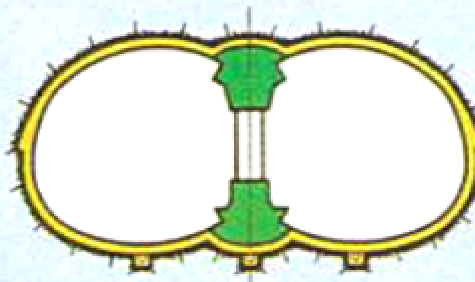

5 Excavation and support of the two middle drifts

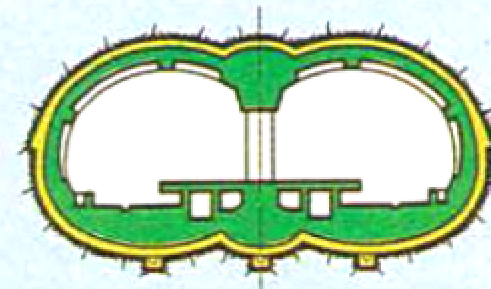

6 Lining construction

Milestones – Milníky

1991 Fort Totten Metro Station, Washington DC, USA



Milestones – Milníky

1991 Fort Totten Metro Station, Washington DC, USA



Side Drift Excavation

Milestones – Milníky

1991 Fort Totten Metro Station, Washington DC, USA



Milestones – Milníky

1991 Fort Totten Metro Station, Washington DC, USA



Projects – Projekty Amerika

1992 Metro Los Angeles, Red Line, USA

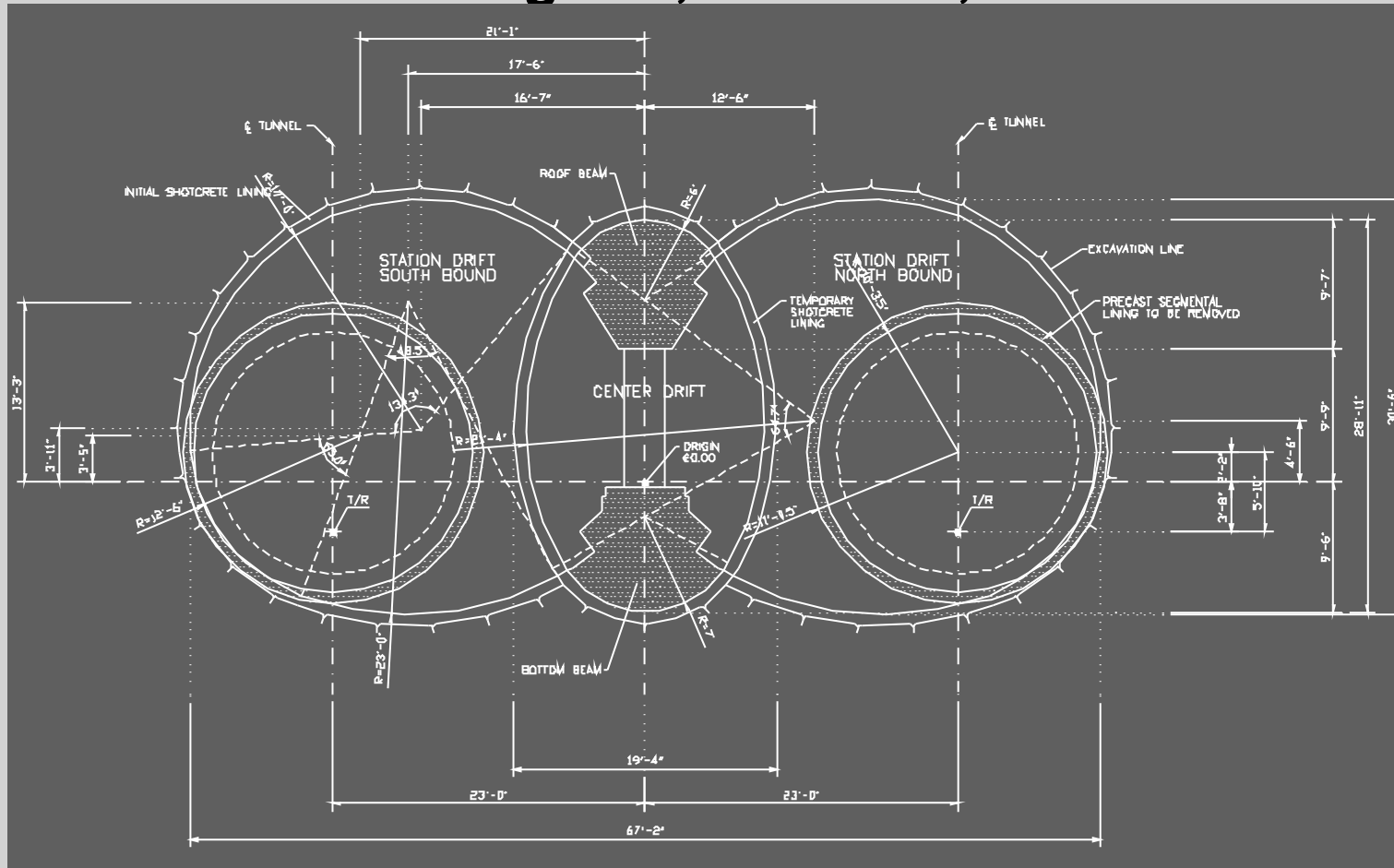

Hybrid Station Conventional / TBM

Projects – Projekty Amerika

2001 Sound Transit Seattle, USA

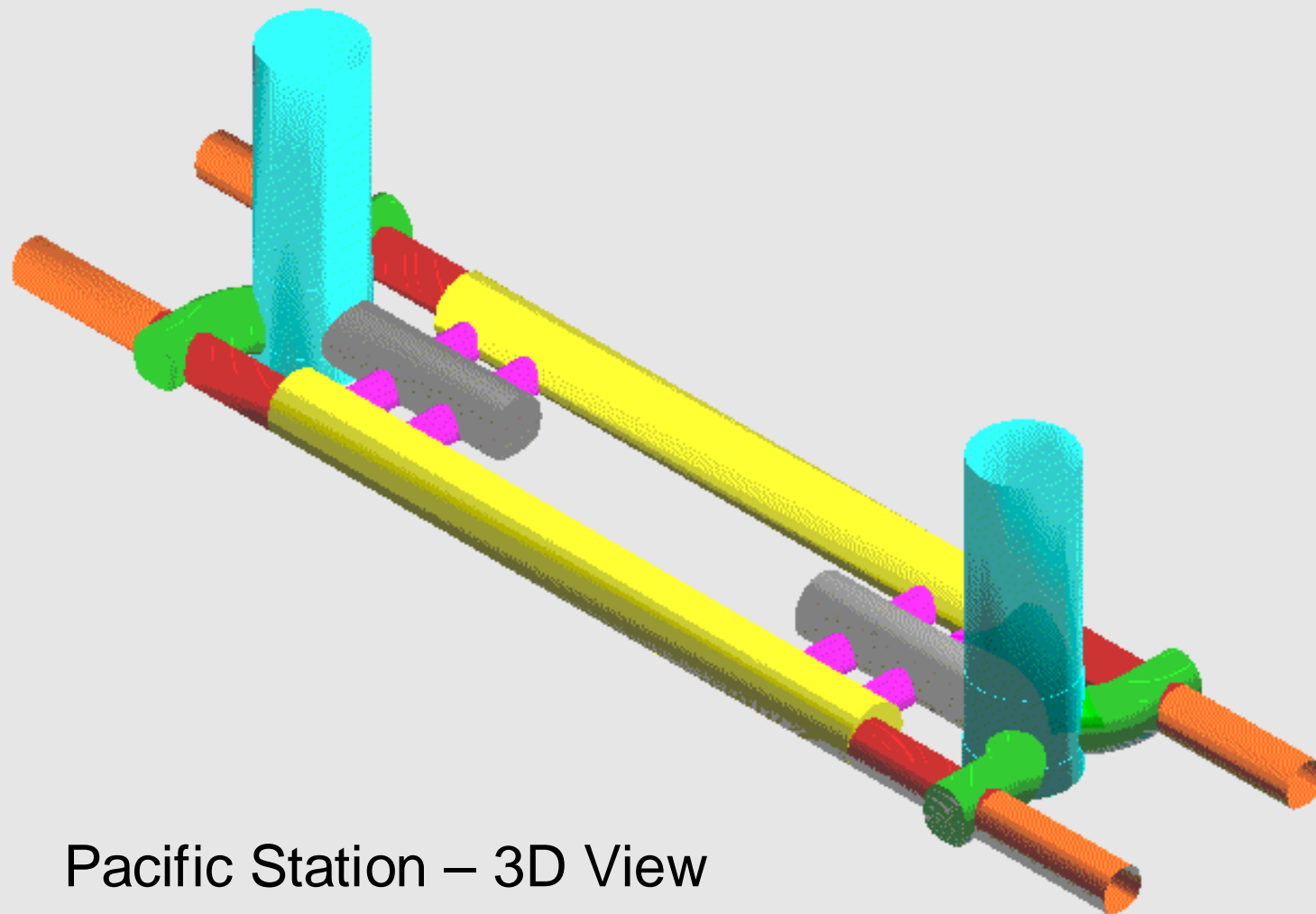

Pacific Station – 3D View

Projects – Projekty Amerika

2012 Sound Transit Seattle, USA



Projects – Projekty Amerika

2000 Metro San Juan, Puerto Rico

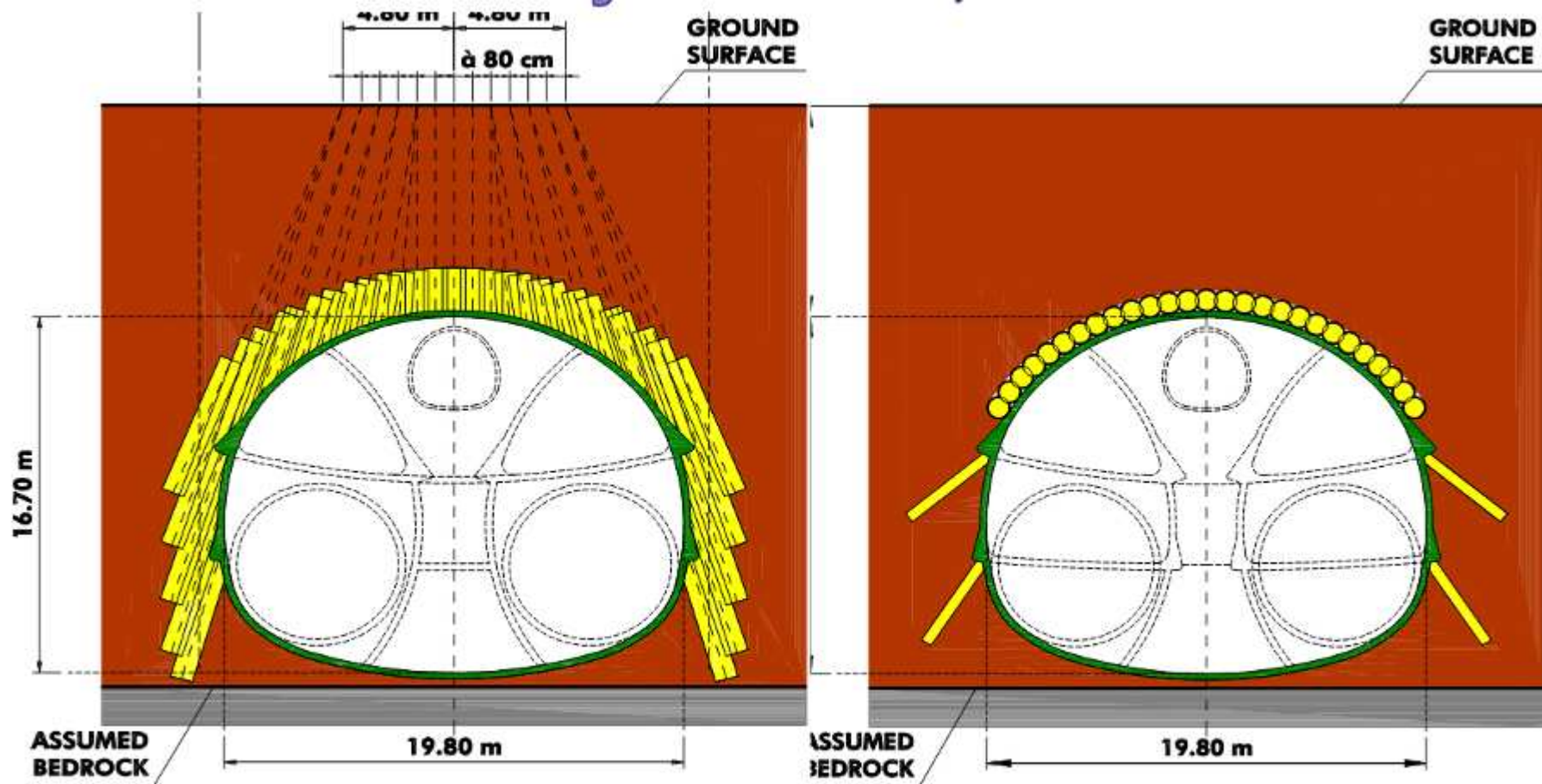

Hybrid Station Conventional / TBM

Projects – Projekty Amerika

1999 - 2002 East Side Access (ESA) New York – USA

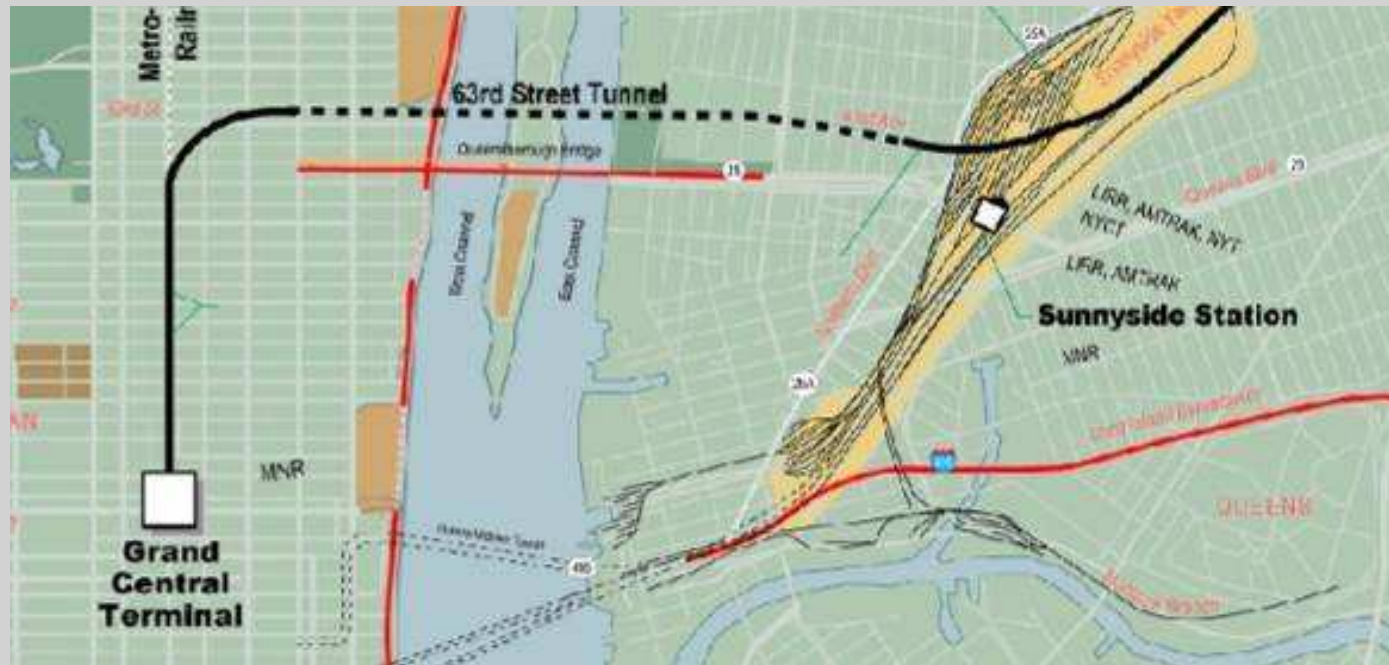

1972 - 63rd Street Tunnel

1989 – partial operation

2016 – ESA operation

Projects – Projekty Amerika

2012 Edmonton LRT, Canada



Strana 26

Projects – Projekty Evropa

2004 - 2009 Metro Line 4, Budapest - Hungary

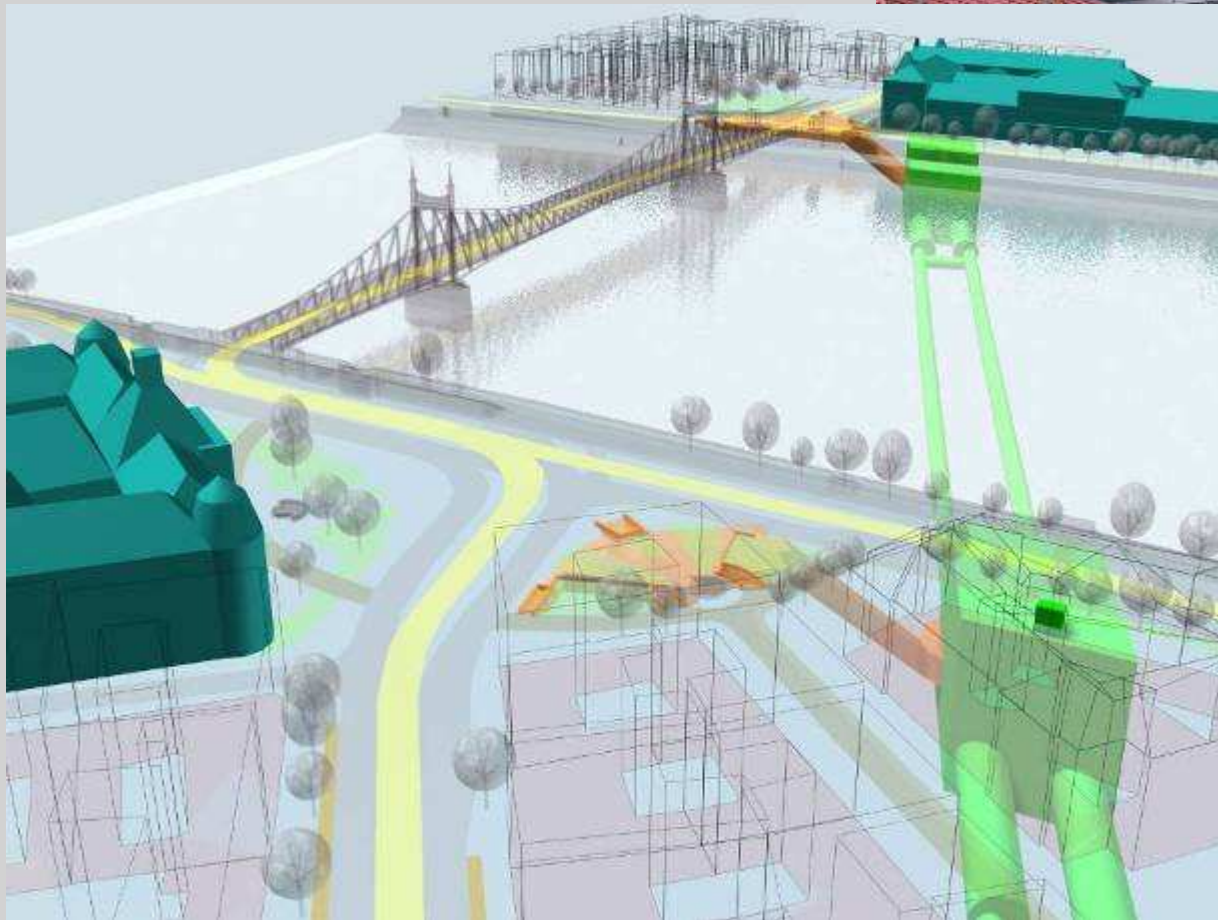

Projects – Projekt Evropa

2004 - 2009 Metro Line 4, Budapest - Hungary

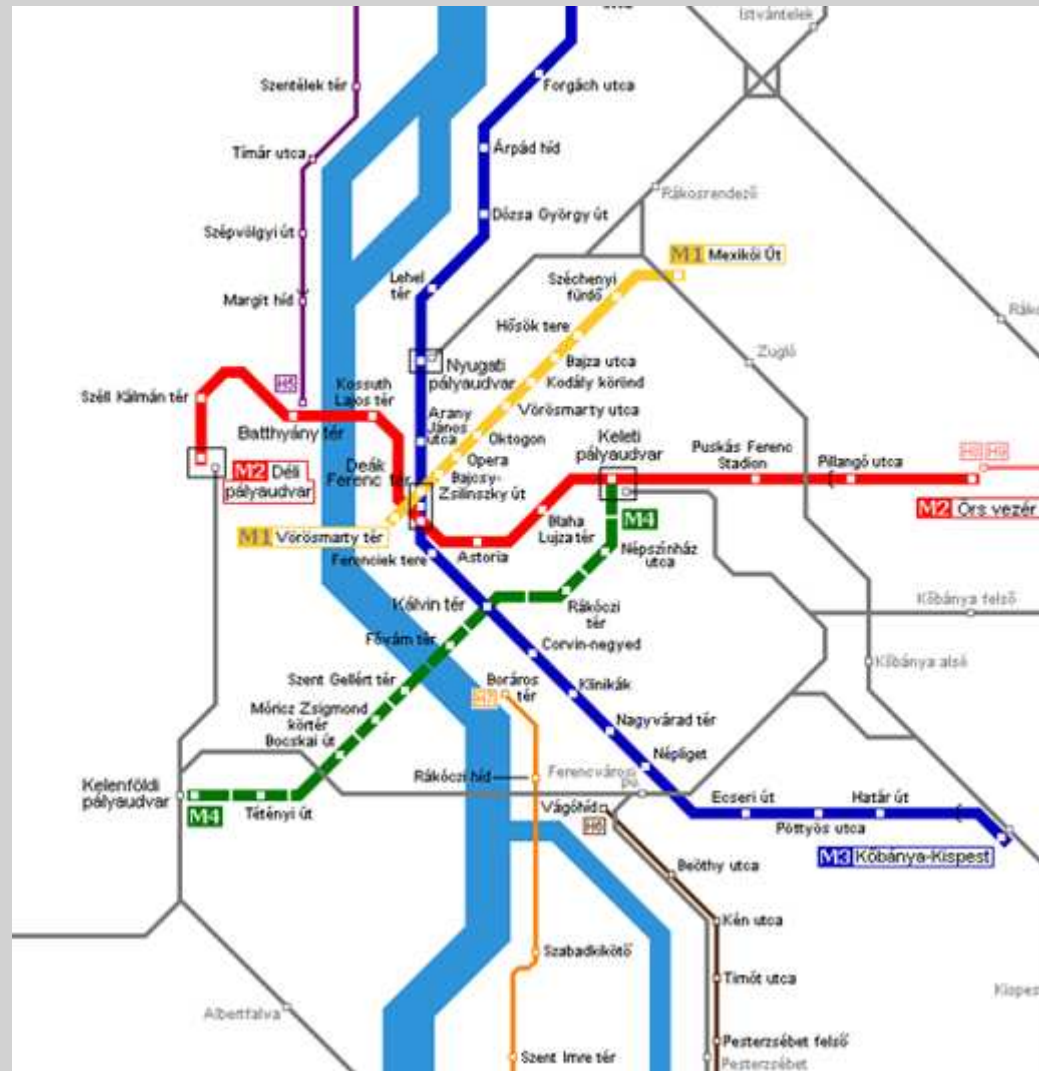

1896 – 2012

32 km

40 stations

Projects – Projekty Evropa

2004 - 2009 Metro Line 4, Budapest - Hungary

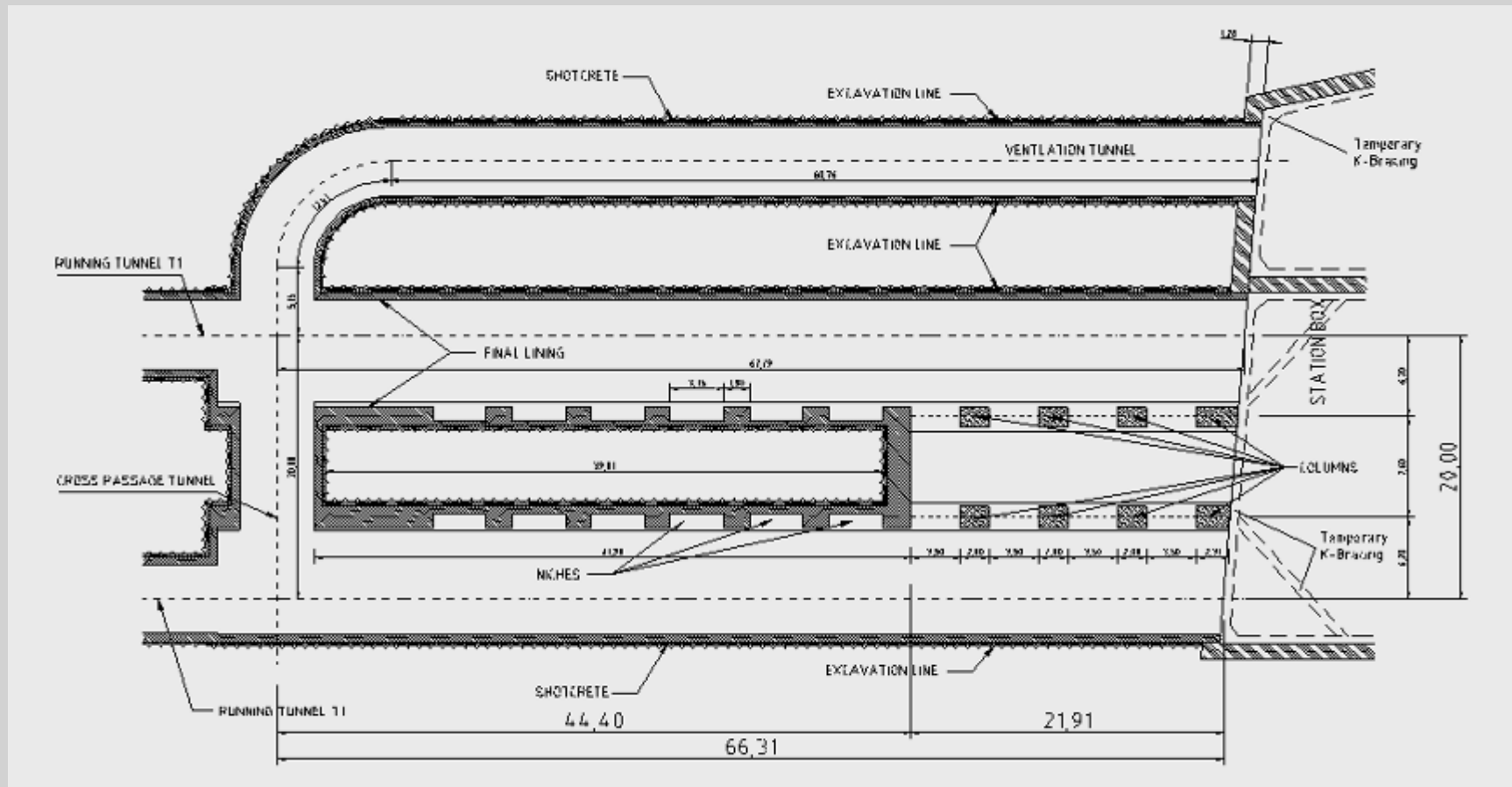

Gellert Ter Station

Projects – Projekty Evropa

2004 - 2009 Metro Line 4, Budapest - Hungary

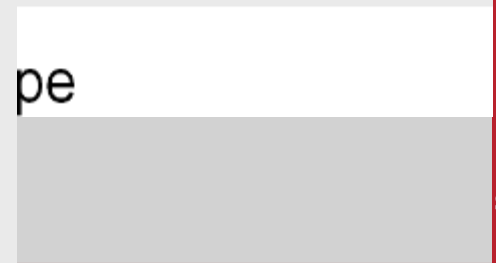
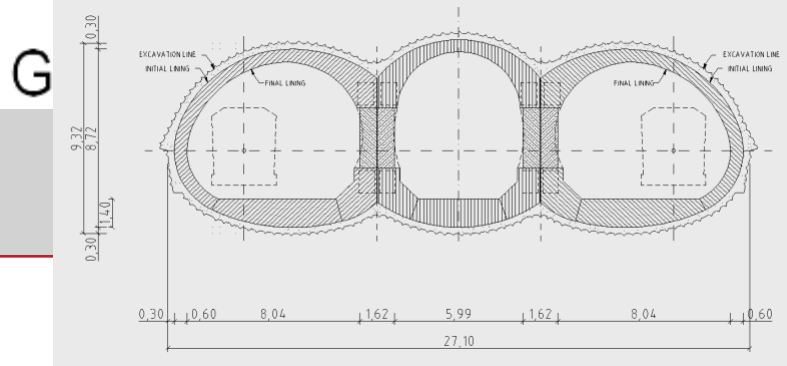
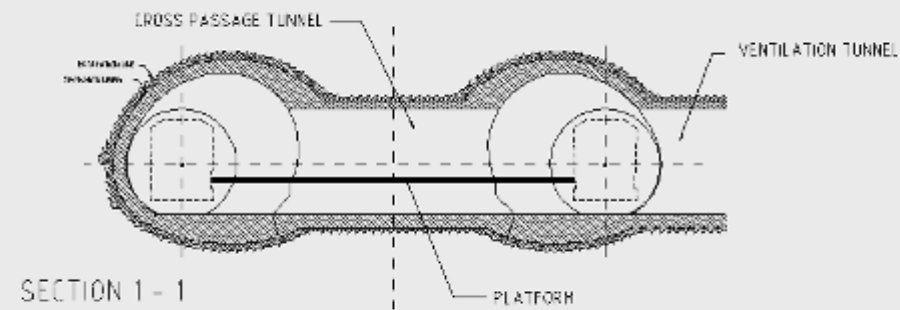
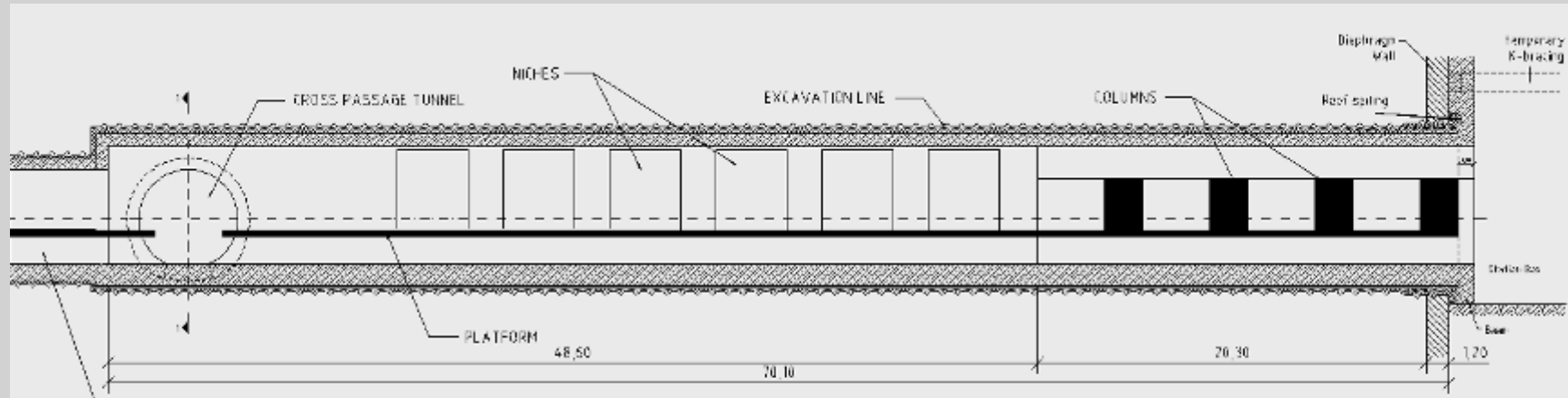

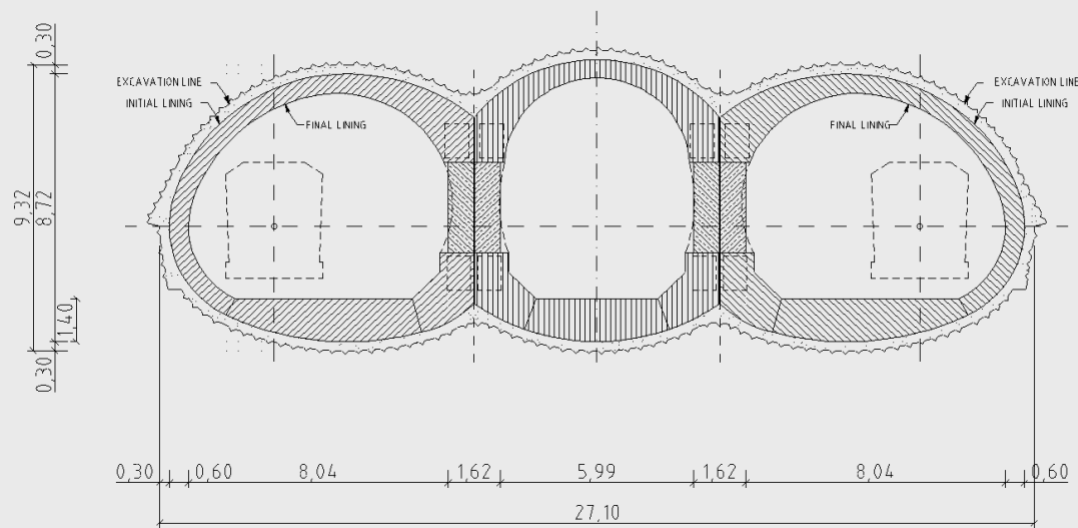

Projects – Projekty Asie

2000 Metro New Delhi - India

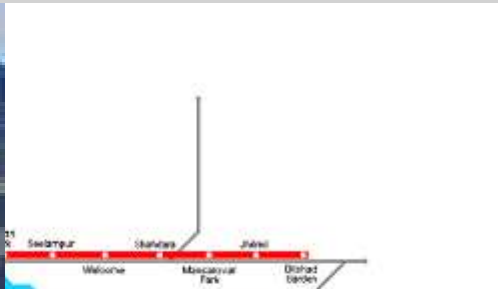

2003 – 2012

190 km

140 stations

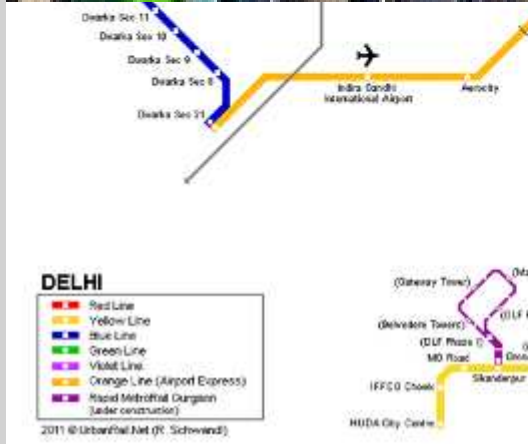

Projects – Projekty Asie

2000 Metro New Delhi - India

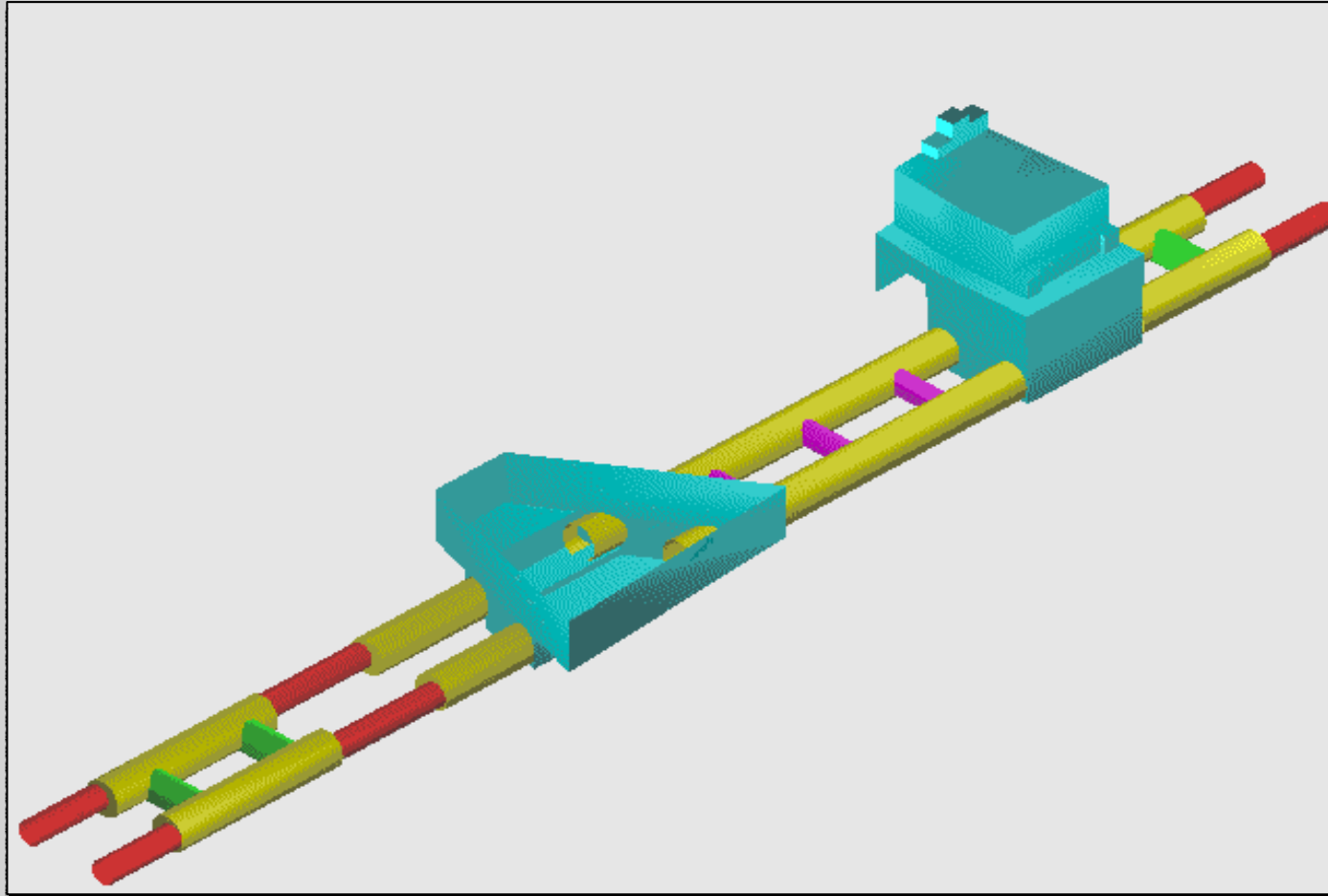

Chawri Bazar Station – 3D View

Projects – Projekty Asie

2000 Metro New Delhi - India

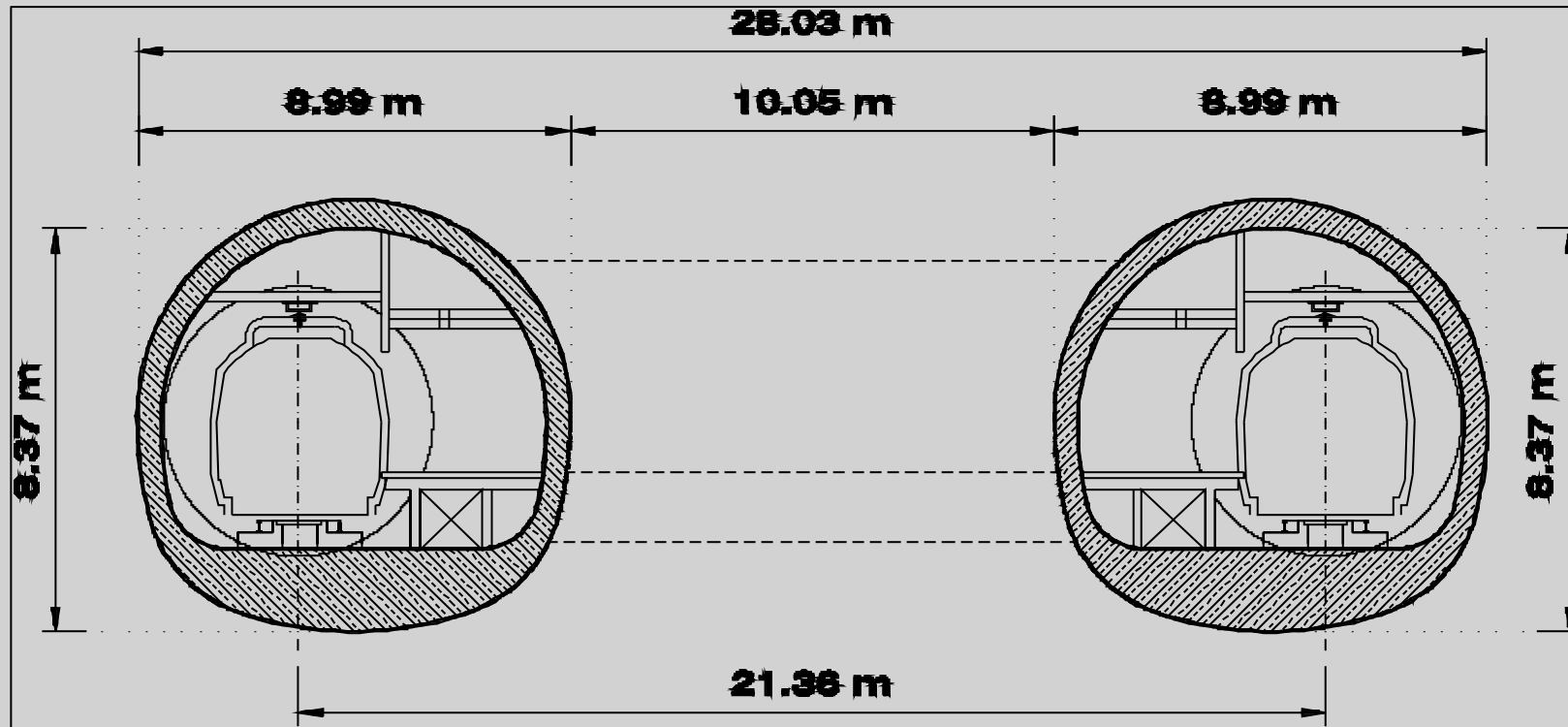

Chawri Bazar Station Cross Section

Projects – Projekty Asie

2008 Metro Bangkok Blue Line, Thailand

2000 – 2012

81 km

56 stations



Projects – Projekty Asie

2008 Metro Bangkok Blue Line, Thailand

TRIPLE PHASE RISK CONTROL

TBM

PHASE 1

C&C

PHASE 2

NATM

PHASE 3

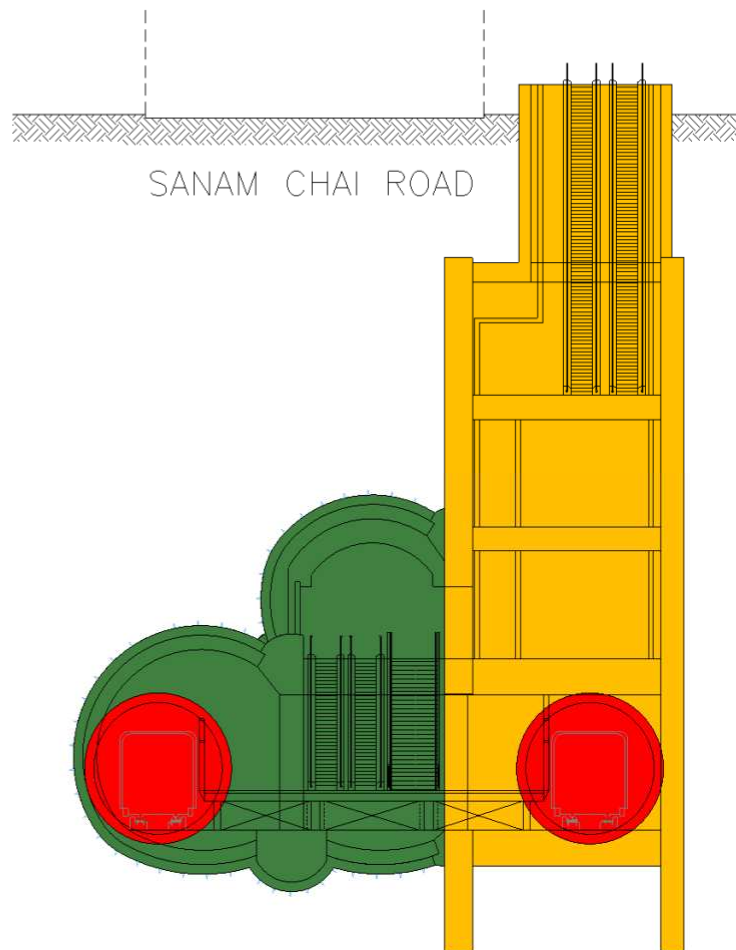

Strana 36

Projects – Projekty Asie

2008 Metro Bangkok Blue Line, Thailand

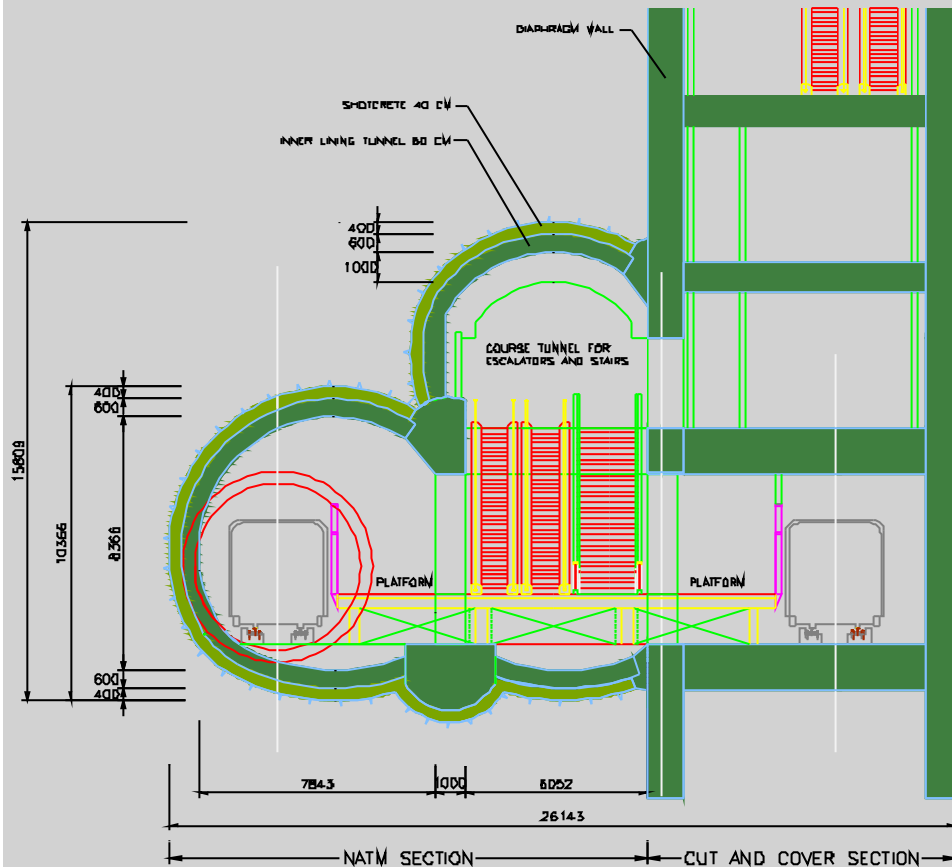



Bangkok WTC 2012 May 18 -24

Strana 38